

## BIONOMADIX SERIES

The BioNomadix system is a wireless, multi-channel physiological recording platform. Its untethered design allows for nearly unlimited freedom of movement and unsurpassed comfort, enabling subjects to easily relax into their protocol. There are twelve different BioNomadix modules sets, each consisting of a matched transmitter and receiver specifically optimized for desired physiological signals. Multiple BioNomadix module sets (typically eight maximum) can be used to create a customized BioNomadix system.



Each BioNomadix module set is capable of recording of two independent channels, with the exception of the Accelerometer module, which records three channels.

## BIONOMADIX TRANSMITTER AND RECEIVER SETS

BN-ACCL3	BioNomadix Accelerometer	BN-DYNEMG	BioNomadix Dynamometry and EMG
BN-ECG2	BioNomadix 2-Channel ECG	BN-EOG2	BioNomadix 2-Channel EOG
BN-EEG2	BioNomadix 2-Channel EEG	BN-NICO	BioNomadix Cardiac Output
BN-EGG2	BioNomadix 2-Channel EGG	BN-RSP2	BioNomadix 2-Channel Respiration
BN-EMG2	BioNomadix 2-Channel EMG	BN-RSPEC	BioNomadix RSP and ECG
BN-PPGED	BioNomadix PPG and EDA	BN-SKT2	BioNomadix 2-Channel Skin Temp
BN-GONIO	BioNomadix 2-Channel Goniometry	BN-STRIKE	BioNomadix 2-Channel Heel/Toe Strike

BioNomadix [BN-GYRO-75](#) and [BN-GYRO-300](#) Angular Rate Sensors are [discontinued items](#).

## BIONOMADIX TRANSMITTER ONLY

BN-ACCL3-T	Accelerometer	BN-DYNEMG-T	Dynamometry and EMG
BN-ECG2-T	2-Channel ECG	BN-EOG2-T	2-Channel EOG
BN-EEG2-T	2-Channel EEG	BN-NICO-T	Cardiac Output
BN-EGG2-T	2-Channel EGG	BN-RSP2-T	2-Channel Respiration
BN-EMG2-T	2-Channel EMG	BN-RSPEC-T	RSP and ECG
BN-PPGED-T	PPG and EDA	BN-SKT2-T	2-Channel Skin Temp
BN-GONIO-T	Goniometry	BN-STRIKE-T	2-Channel Heel/Toe Strike

🔗 Click to view a [BioNomadix System Diagram](#).

## BIONOMADIX LOGGER (BN-LOGGER) *Get the real-world data your application demands!*

BioNomadix Loggers wirelessly record physiological data as subjects freely and naturally live their lives—record from up to three dual-channel wearable BioNomadix Transmitters\* plus a built-in accelerometer. Sync the BioNomadix Logger with GPS for a correlation between physiological and location data.

Use as a stand-alone system with *AcqKnowledge* or combine with BioNomadix Receivers and a computer running *AcqKnowledge*:



- Sync Transmitters to the Logger mode for remote data logging.
- Combine Transmitters with BioNomadix wireless Receivers to operate in the lab for real-time telemetry.

The compact Logger device provides a color display for visual feedback, speaker for auditory feedback, vibration for haptic feedback, voice journal for participant comments, event markers, and alarms. Includes micro-USB to USB cable for charging/data transfer, AC Charger and belt case.

\* Existing BioNomadix devices require a firmware upgrade to be compatible with Loggers—see [BN-TX-UPG](#) online for details.

**NOTE:** BioNomadix Logger requires *AcqKnowledge* software version 4.4.1 or higher.

### BioNomadix Logger Specifications

<b>Weight:</b> 121.2 grams	<b>Transmitter:</b> Ultra-low power 2.4 GHz bi-directional digital RF transmitter
<b>Dimensions:</b> 9.42 cm x 5.76 cm x 2.3 cm	<b>Rate:</b> 2 kHz, maximum
<b>Screen:</b> Color, 6 cm diagonal	<b>RF reception range:</b> 1 meter (line of sight, approx.)
<b>Memory:</b> 32 GB	<b>Charger:</b> Integrated USB charger with AC wall adapter BN-LOG-CHRG
<b>Battery:</b> 1800 mAh Lithium-ion	<b>Compliance:</b> FC, CE, IC, VCCI -FCC Part 15 B FCC ID: ZWIBNXT1, IC: 9901A-BNXT1
<b>Operating time:</b> 24 hours (recording)	<b>Built-in Accelerometer:</b> X, Y, Z – axes; rate 100-400 Hz; Range: ±2-16 G
<b>Time to full charge:</b> ~12 hours	

➔ Click to view a [BioNomadix Logger System Diagram](#).

### BIONOMADIX ELECTRODE LEAD SET (use with wireless and Smart Amplifiers)

BN-EL15-LEAD2	Electrode Lead 2 x 15 cm to BioNomadix or 100D Smart Amps
BN-EL15-LEAD3	Electrode Lead 3 x 15 cm to BioNomadix or 100D Smart Amps
BN-EL30-LEAD2	Electrode Lead 2 x 30 cm to BioNomadix or 100D Smart Amps
BN-EL30-LEAD3	Electrode Lead 3 x 30 cm to BioNomadix or 100D Smart Amps
BN-EL45-LEAD2	Electrode Lead 2 x 45 cm to BioNomadix or 100D Smart Amps
BN-EL45-LEAD3	Electrode Lead 3 x 45 cm to BioNomadix or 100D Smart Amps
BN-EL50-LEAD2	Electrode Lead 2 x 50 cm to BioNomadix BN-NICO
BN-EL50-LEAD4	Electrode Lead 4 x 50 cm to BioNomadix BN-NICO
BN-EDA-LEAD2	EDA Electrode Lead 2 x 15 cm to BioNomadix BN-PPGED or Smart Amplifier EDA100D
BN-EDA25-LEAD2	EDA Electrode Lead 2 x 25 cm to BioNomadix BN-PPGED or Smart Amplifier EDA100D
BN-ADAPT-2	Adapter 2 x 10 cm for connecting 1.5 mm Touchproof leads to BN Transmitter
BN-ADAPT-3	Adapter 3 x 10 cm for connecting 1.5 mm Touchproof leads to BN Transmitter

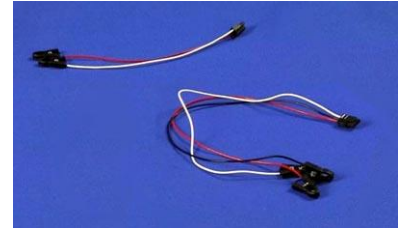

### BIONOMADIX TRANSDUCERS (use with wireless and Smart Amplifiers)

BN-PULSE-XDCR	Pulse Transducer for BioNomadix BN-PPGED or Smart Amplifier PPG100D
BN-PULSEEAR-XDR	Pulse Earclip Transducer for BioNomadix BN-PPGED or Smart Amplifier PPG100D
BN-RESP-XDCR	Respiration Transducer for BioNomadix BN-RSP2, BN-RSPEC, or Smart Amplifier RSP100D
BN-TEMP-A-XDCR	Skin Temp Skin Transducer for BioNomadix BN-SKT2 or Smart Amplifier SKT100D
BN-TEMP-B-XDCR	Fast-Response Temp Transducer for BioNomadix BN-SKT2 or Smart Amplifier SKT100D
BN-STRIKE-XDCR	Heel-Toe Strike Transducer for BioNomadix BN-STRIKE
BN-GON-110-XDCR	Twin-axis Goniometer Transducer for BioNomadix BN-GONIO
BN-GON-150-XDCR	Twin-axis Goniometer Transducer for BioNomadix BN-GONIO
BN-TOR-110-XDCR	Single-axis Torsiometer Transducer for BioNomadix BN-GONIO
BN-TOR-150-XDCR	Single-axis Torsiometer Transducer for BioNomadix BN-GONIO
BN-GON-F-XDCR	Single-axis Goniometer Transducer for BioNomadix BN-GONIO

### BIONOMADIX ACCESSORIES

#### Straps

BN-STRAP-20	BioNomadix Strap 20 cm x 25.4 mm
BN-STRAP-33	BioNomadix Strap 33 cm x 25.4 mm
BN-STRAP-76	BioNomadix Strap 76 cm x 25.4 mm
BN-STRAP-137	BioNomadix Strap 137 cm x 25.4 mm

#### EEG Caps (for BN-EEG2)

BN-EEGCAP-SYS	BioNomadix 10/20 EEG Cap System
BN-CAP-SMALL	BioNomadix EEG Cap – Small (50-54 cm)
BN-CAP-MEDIUM	BioNomadix EEG Cap – Medium (54-58 cm)
BN-CAP-LARGE	BioNomadix EEG Cap – Large (58-62 cm)

#### Chargers

BN-BAT-CHRG for Transmitters, – full charge lasts 72-90 hours, full charge in approximately 1 hr.  
BN-LOG-CHRG for Loggers – full charge lasts 24 of operation with 30 days stand-by, full charge in approximately 12 hours. Both chargers provide a lifespan of 500 charge/discharge cycles—or 35,000 hours!

**BIONOMADIX SHIRT (BN-SHIRT)**



Use this stretch mesh shirt to comfortably hold multiple devices in place when subjects will have several BioNomadix transmitters attached to their body—wear as is or under clothing. Pockets hold the transmitter and have reinforced access slots to pass leads through for connection, plus zippers add easy access to attachment sites. Select size so the shirt is worn tight to hold the BioNomadix transmitter and sensors in place.

The BioNomadix shirt provides a greater degree of comfort and mounting flexibility for multi-sensor studies.

The shirt allows the subject to wear the devices in natural and well balanced positions for long-term physiological studies exercise regimes. This natural, unhindered environment significantly improves the quality of the data, and makes it much easier for subjects to respond naturally. Available sizes, extra small, small, medium, large, and extra large (see sizing dimensions below).

- **22 pockets:** 2 neck front, 2 neck back, 4 chest center, 4 back center, 2 hip front, 2 hip back, 3 left arm , 3 right arm
- **4 zippers:** right front from arm to hip, left back from shoulder to hip, right and left under arm from neck front to neck back
- **4 strap bands:** 4 rows of strap bands (2 loops front, 2 loops back) for RSP transducer strap

**BIONOMADIX SHIRT SIZING**

	BN-SHIRT-XS	BN-SHIRT-S	BN-SHIRT-M	BN-SHIRT-L	BN-SHIRT-XL
Front: Chest	38.7 cm (15.25")	40.6 cm (16")	42.5 cm (16.75")	47.6 cm (18.75)	52.7 cm (20.75")
Front: Waist	29.2 cm (11.5")	31.8 cm (12.5")	34.3 cm (13.5")	39.4 cm (15.5")	43.8 cm (17.25")
Front: Hip	28.6 cm (11.25")	30.5 cm (12")	33 cm (13")	38.1 cm (15")	43.8 cm (17.25")
Back: Chest	44.5 cm (17.5")	47.6 cm (18.75")	48.9 cm (19.25")	53.3 cm (21")	60.3 cm (23.75")
Back: Waist	36.5 cm (14.375")	39.4 cm (15.5")	45.7 cm (18")	45.7 cm (18")	51.4 cm (20.25")
Back: Hip	36.2 cm (14.25")	39.4 cm (15.5")	45.7 cm (18")	45.7 cm (18")	51.4 cm (20.25")
Back: Length	61 cm (24")	62.2 cm (24.5")	64.8 cm (25.5")	67.9 cm (26.75")	71.1 cm (28")

**BIONOMADIX BIOSHIRT (BN-BIOSHIRT)**



**Smart shirt simultaneously acquires ECG and Respiration data while subjects roam freely**

The lightweight, comfortable BioNomadix BioShirt contains a respiration sensor and fabric electrodes to wirelessly record both respiration and ECG while ambulatory subjects move freely and perform tasks in short or long-term studies, in the lab, or in the real world. The shirt connects to a wireless BioNomadix [BN-RSPEC Respiration & ECG Transmitter](#) placed in a small pocket on the front of the BioShirt—no electrodes, gels, or wires to fuss over. Transmit data to either a stand-alone BioNomadix [Smart Center, Logger](#) or an [MP160/150 System](#) with matched BioNomadix Receiver module.

[BioNomadix wireless recording](#) and [AcqKnowledge software](#) provide a powerful, complete solution that supports advanced analysis for [applications](#) and [measurements](#) for a variety of physiological parameters, including: Heart rate, respiration rate, Heart rate variability (HRV), Respiratory Sinus Arrhythmia (RSA), etc.

Combine with the [Logger](#), [GPS tracker](#), and other wireless sensing devices for comprehensive analysis of your subject’s experience. The Logger’s accelerometer can provide activity information, the GPS will provide a history of a subject’s movements.

Sized separately for men and women, for a snug fit below the bust to maintain sensor contact.

**BIOSHIRT SPECIFICATIONS**

Attachment Features:	Single-pocket Smart Shirt holds BN-RSPEC Transmitter (Respiration and ECG), woven-in fabric electrodes	
Materials:	76% Nylon/Polymid, 23% Elastane, 1% Polyester	
Sizes: (M = Male, F = Female)	BN-BIOSHIRT-MS 76-82 cm (29.9-32.2")	BN-BIOSHIRT-FXS 65-69 cm (25.5-27.1")
	BN-BIOSHIRT-MM 83-89 cm (32.6-35.0")	BN-BIOSHIRT-FS 69-73 cm (27.1-28.7")
	BN-BIOSHIRT-ML 90-96 cm (35.4-37.8")	BN-BIOSHIRT-FM 73-77 cm (28.7-30.3")
	BN-BIOSHIRT-MXL 97-103 cm (38.2-40.5")	BN-BIOSHIRT-FL 77-81 cm (30.3-31.9")
	BN-BIOSHIRT-MXXL 104-110 cm (40.9-43.3")	BN-BIOSHIRT-FXL 81-85 cm (31.9-33.5")
	BN-BIOSHIRT M3XL 111-117 cm (43.7-46.0")	BN-BIOSHIRT F2XL 85-89 cm (33.5-35.0")
	BN-BIOSHIRT M4XL 118-124 cm (46.4-48.8")	BN-BIOSHIRT F3XL 89-93 cm (35.0-36.6")
		BN-BIOSHIRT F4XL 93-97 cm (36.6-38.1")
Care Instructions:	Wash separately, line dry, no fabric softener	

## SETUP OVERVIEW

1. Setup the BioNomadix transmitter with subject.
2. Setup the BioNomadix receiver.
3. Setup the software.



## HARDWARE SETUP

Transmitter and Receiver units are shipped as a matched pair and must always be used as a pair (see serial number and ID sync options). Up to 16 channels per BioNomadix system can be monitored simultaneously, returning data quality equal to standard BIOPAC MP modules. Normal operating range between transmitter and receiver is 10 meters line of sight in standard laboratory environments. For additional guidelines, see BioNomadix Operational Range and Characteristics on page 12.

## BIONOMADIX TRANSMITTER

### Setup

1. Connect the electrode lead set or transducer to the BioNomadix Transmitter module inputs. Squeeze lock connector and push until it clicks into place. CH A and CH B require an appropriate lead set or transducer based on signal type.
2. Attach electrodes and electrode leads or transducer to the Subject Position.
3. Secure the Transmitter module on Subject, (i.e. with a strap, or inside a BioNomadix shirt pocket).
  - For optimum results, the BioNomadix Custom Sport Shirt or BioShirt is recommended. This specially-designed shirt is made of a lightweight material with numerous “pockets” for housing multiple transmitters. The BioNomadix Shirt incorporates zippered openings for positioning electrode leads properly. The BioNomadix BioShirt has one pocket for use with a BN-RSPEC (Respiration and ECG) Transmitter and “smart” electrodes woven into the fabric.
4. Set the power switch on the BioNomadix Transmitter to ON. The Status light will flash sequences based upon connectivity and battery life.
5. Double blinks occurring every two seconds indicate successful pairing and normal operation between transmitter and receiver.

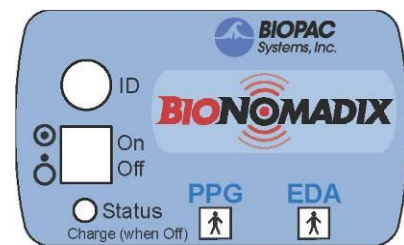

## CONTROLS

**ID:** Press to illuminate Status light of matching Receiver unit.

**On/Off:** Power switch for the transmitter. The transmitter power must be turned OFF for charging.

**Status:** Solid amber when battery power is low. Approximately one hour of operation remains after light turns amber, full-charge with BN-BAT-CHRG battery charger typically requires one hour.

**Channels:** Connect the electrode leads to the matched BioNomadix Transmitter module inputs. (Squeeze lock connector and push until it clicks into place).

## BIONOMADIX RECEIVER

### BEFORE BEGINNING:

- Decide whether one or both available channels will be used. (If using only one channel, set “**A**” to ON and “**B**” to OFF.)
- Decide which channel bank will be used and select “**X**” or “**Y**.”
- Set channel slider to correct position.
- Attach Receiver unit to the right side of the MP160/150 unit, or the left side of the IPS100C. The Status light will turn green when communicating with transmitter. As with standard BIOPAC hardware, additional modules can be attached to the receiver.
- Set desired channel options on the Receiver module.

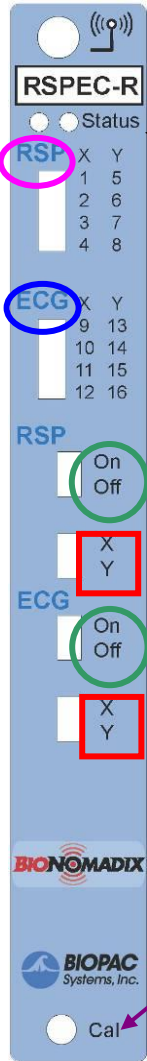

The **RSPEC** Receiver unit is depicted, but controls operate similarly for all units.

 Wireless antenna input

**Receiver LED:** Steady green when paired with transmitter. Blinks amber once per second when communication is interrupted.

**Input Signals:** **A** = ● **B** = ●

“**A**” Assigns the input signals for channels 1-8.

“**B**” Assigns the input signals for channels 9-16.

**On/Off** ●

Enables or disables module channels: “**A**” channels 1-8 “**B**” channels 9-16.

**X/Y channel banks** ■

Selects between “**X**” channel bank or “**Y**” channel bank.

“**A**” **X** bank is 1-4, **Y** bank is 5-8.

“**B**” **X** bank is 9-12, **Y** bank 13-16.

**NOTE:** “**A**” or “**B**” banks that are turned off will free up those associated Analog channels for use by other signal types.

**Cal:** Recessed Calibration button. **NOTE:** Calibration is not required, most users can use factory presets. Calibration is an advanced procedure.

## TRANSMITTER BATTERY LIFE

Transmitter battery life is described below as a change of color in the sequence of LED flashes.

LED Color Pattern				Charge %
green	green	green	green	75% - 100%
yellow	green	green	green	50% - 75%
yellow	yellow	green	green	25% - 50%
yellow	yellow	yellow	green	5% - 25%
yellow	yellow	yellow	yellow	< 5%

**IMPORTANT:** *If the transmitter is to be stored for prolonged periods, it is strongly recommended that the battery be fully charged and the transmitter turned off prior to storage. Failure to do so may result in permanent damage to the battery.*

## SOFTWARE SETUP

### Recording data with AcqKnowledge software

After completing setup, click Start in the AcqKnowledge software to begin recording data.

If the paired signal is interrupted due to electrical interference or a subject wandering out of range, the most recently-acquired data point will be retained, with normal acquisition continuing once communication is reestablished. See also: [BioNomadix Operational Range and Transmission Characteristics](#).

## FULL BIONOMADIX MODULE SPECS

Table 1: BioNomadix Dual Biopotential Pairs – See Table 2 for Dual Transducer, Table 3 for Combo Pairs, and Table 4 for Accelerometer

BioNomadix Pair	BN-ECG2	BN-EEG2	BN-EGG2	BN-EMG2	BN-EOG2
<b>Signal type:</b>	Dual Channel ECG	Dual Channel EEG	Dual Channel EGG	Dual Channel EMG**	Dual Channel EOG
<b>Bandlimits Max:</b> <b>Factory preset:</b> <b>Filter options:</b>	0.05 Hz to 150 Hz 1 Hz to 35 Hz 0.05 or 1 Hz HP, 35 or 150 Hz LP	0.1 Hz to 100 Hz 0.5 Hz to 35 Hz 0.1 or 0.5 Hz HP, 35 or 100 Hz LP	0.005 Hz to 1.0 Hz 0.005 Hz to 1.0 Hz 0.005 Hz HP, 1 Hz LP	5 Hz to 500 Hz 10 Hz to 500 Hz 5 or 10 Hz HP, 250 or 500 Hz LP	0.005 Hz to 100 Hz 0.005 Hz to 35 Hz 0.005 or 1 Hz HP, 35 or 100 Hz LP
<b>Alternative signal:</b>	Heart Rate Mode	Delta, Theta, Alpha, Beta		Envelope Detection Mode	Derivative Mode
<b>Notch filter:</b>	50/60 Hz user-controlled switch; typically not required—factory preset OFF. See Appendix for more hardware-specific output options.				
<b>Noise Voltage</b> (shorted inputs):	0.9 $\mu$ V rms (bandwidth of 0.05 Hz to 150 Hz)	0.2 $\mu$ V rms (bandwidth of 0.10 Hz to 100 Hz)	0.5 $\mu$ V rms (bandwidth of 0.005 Hz to 1 Hz)	1.5 $\mu$ V rms (bandwidth of 1.0 Hz to 500 Hz)	0.9 $\mu$ V rms (bandwidth of 0.005 Hz to 100 Hz)
<b>Input Voltage Range:</b>	up to 10 mV P-P	up to 2 mV P-P	up to 10 mV P-P	up to 10 mV P-P	up to 10 mV P-P
<b>Output Voltage Range:</b>	$\pm$ 10 V (receiver output)				
<b>CMRR</b>	110 dB typical at 50/60Hz; 90dB minimum for ECG, EEG, EMG, and EOG, 100 db minimum for EGG				
<b>CMII</b>	1000 M $\Omega$ (50/60 Hz)				
<b>Differential Input Impedance:</b>	2 M $\Omega$				
<b>Fixed Gain:</b>	2,000	10,000	2,000	2,000	2,000
<b>Operating Time:</b>	72-90 hours				
<b>Included strap:</b>	137 cm - BN-STRAP137	76 cm - BN-STRAP76	137 cm - BN-STRAP137	33 cm - BN-STRAP33	76 cm – BN-STRAP76
<b>Size &amp; Weight:</b>	Transmitter (approx.): 6 cm x 4 cm x 2 cm; 54 grams; Receiver (approx.): 4 cm x 11 cm x 19 cm; 380 grams				
<b>Input:</b>	See BioNomadix electrode lead cable options (BN-ELxx-LEADx). Each biopotential transmitter requires at least one GND. To eliminate redundant biopotential GND, use a 3-lead electrode lead cable for one input (CH A or B) and a 2-lead electrode lead cable for the other input (CH A or B) on each BioNomadix transmitter. Use BN-ADAPT-TP2/3 for Touchproof connections, including BN-EEGCAP-SYS.				

**\*\*NOTE for BN-EMG2:** Due to digital data buffering and wireless transmission factors (large fixed component (15.6 ms) and small variable component ( $\pm$ 0.5 ms rms), the BN-EMG2 module is not recommended for applications such as Nerve Conduction Velocity or any physiological signal where equivalently small timing differences are being measured. For these types of studies, BIOPAC recommends the wired [EMG100C](#) amplifier.

Table 2: BioNomadix Dual Transducer – See Table 1 for Biopotentials, Table 3 for Combo Pairs, and Table 4 for Accelerometers

BioNomadix	BN-SKT2	BN-RSP2	BN-GONIO	BN-STRIKE
<b>Signal type:</b>	Dual Channel SKT <i>temp</i>	Dual Channel RSP <i>resp</i>	Dual Channel Goniometry	Dual Channel Strike Data
<b>Bandlimits/Max:</b>	DC to 10 Hz	DC to 10 Hz	DC to 100 Hz	DC to 100 Hz
<b>Factory preset:</b>	DC to 1 Hz	DC to 1 Hz	DC to 10 Hz	DC to 10 Hz
<b>Filter Options:</b>	DC, 0.5 Hz HP, 1 or 10 Hz LP	DC, 0.5 Hz HP, 1 or 10 Hz LP	DC, 3 Hz, 10 Hz, or 100 Hz LP	DC, 3 Hz, 10 Hz, or 100 Hz LP
<b>Notch filter:</b>	50/60 Hz user-controlled switch; typically not required—factory preset OFF. See Appendix for additional hardware-specific output options.			50/60 Hz user-controlled switch – factory preset OFF
<b>Resolution:</b>	0.01° C (rms)	FSR/4096; (4.88 mV)	0.01° rotation (rms)	N/A
<b>Signal range:</b>	13 to 51° C	± 10 V (at output)	± 180°	± 10 V (at output)
<b>Output Voltage range:</b>	± 10 V (receiver output)			
<b>Operating time:</b>	72-90 hours			
<b>Included strap:</b>	137 cm - BN-STRAP-137	137 cm - BN-STRAP-137	76 cm - BN-STRAP-76 & BN-STRAP-33	33 cm - BN-STRAP-33
<b>Input:</b>	BN-TEMP-A/B-XDCR	BN-RESP-XDCR	BN-GON-110-XDCR BN-GON-150-XDCR BN-GON-F-XDCR BN-TOR-100-XDCR BN-TOR-150-XDCR	BN-STRIKE-XDCR

### BN-ADAPT-GONIO

This adapter connects goniometers and torsionometers to a wireless BN-GONIO Transmitter, use one adapter per channel.

BioNomadix goniometers and torsionometers include the required BN-ADAPT-GONIO adapter(s):

- Two adapters included with BN-GON-110-XDCR and BN-GON-150-XDCR goniometers
- One adapter included with BN-GON-F-XDCR finger goniometer and BN-TOR-110-XDCR and BN-TOR-150-XDCR torsionometer

Adapters can also be used with existing BIOPAC or 3rd-party goniometers and torsionometers to make them compatible with the BioNomadix wireless transmitter. These adapters are required if not using BioNomadix Transducers.



Table 3: BioNomadix Combo Pairs – See Table 1 for Biopotentials, Table 2 for Dual Transducer and Table 4 for Accelerometer

BioNomadix	BN-RSPEC	BN-PPGED	BN-NICO	BN-DYNEMG
<b>Signal type:</b>	RSP plus ECG	PPG plus EDA	Z and dZ/dt	Dynamometry plus EMG
<b>Excitation:</b>	--	--	Type: Alternating current sine wave Current: 1 mA rms Frequency: 50 kHz	--
<b>BandlimitsMax:</b> <b>Factory preset:</b> <b>Filter Options:</b>	Respiration (CH A): see BN-RSP2 spec ECG (CH B) : see BN-ECG2 spec	Both: DC to 10 Hz: PPG: 0.5 Hz to 3 Hz EDA: DC to 3 Hz Both: DC, 0.5 Hz HP, 3 or 10 Hz LP EDA: 1 Hz LP	Both: DC to 50 Hz* Both: DC to 50 Hz* DC, 1, 3, 5, 50 Hz* LP *Units shipped before 11/2016 are bandlimited to 10 Hz.	Dyn: DC 100 Hz Dyn: DC to 10 Hz Dyn: DC, 3 Hz, 10 Hz, or 100 Hz LP EMG: see BN-EMG2 specs
<b>Notch filter:</b>	50/60 Hz user-controlled switch; typically not required—factory preset OFF. See Appendix for additional hardware-specific output options.			
<b>Resolution:</b>	see BN-RSP2 and BN-ECG2 specs	PPG: FSR/4096; (4.88 mV) EDA: 0.012 $\mu$ S (min step)	Z: nominally $\sim$ 0.05 $\Omega$ (rms) at 10 Hz BW dZ/dt: $\sim$ 0.0075 $\Omega$ /sec (rms) at 10 Hz BW	Dyn: 35 micro kg-f/cm2 (0.0005 psi) (rms) EMG: see BN-EMG specs
<b>Signal range:</b>	see BN-RSP2 and BN-ECG2 specs	PPG: $\pm$ 10 V (at output) EDA: 0 to 50 $\mu$ S; <i>excitation</i> : 0.5 V constant V	Z: 5 to 100 $\Omega$ (mag) dZ/dt: $\pm$ 10 $\Omega$ /sec	Dyn: 0 – 1.055 kg-f/cm2 EMG: up to 10 mV P-P
<b>Output Voltage range:</b>	$\pm$ 10 V (receiver output)			
<b>Operating time:</b>	72-90 hours	24 hours	24 hours	75 hours
<b>Included strap:</b>	137 cm - BN-STRAP137	33 cm - BN-STRAP33	137 cm - BN-STRAP137	33 cm - BN-STRAP-33
<b>Input:</b>	CH A: BN-RESP-XDCR CH B: BN-ELxx-LEAD3	CH A: BN-PULSE-XDCR or BN-PULSEEAR-XDR CH B: BN-EDA-LEAD2 or BN-EDA25-LEAD2	2 x BN-EL50-LEAD4 (or 2 x BN-EL50-LEAD2)	CH A: BN-CLENCH-XDCR CH B: BN-ELxx-LEAD3

Table 4: BioNomadix Accelerometer– See Table 1 for Biopotentials, Table 2 for Dual Transducer, and Table 3 for Combo Pairs

<b>BioNomadix</b>	<b>BN-ACCL3</b>
<b>Signal type:</b>	G (X, Y, Z)
<b>Bandlimits</b> <i>Max:</i> <i>Factory preset:</i> <i>Filter Options:</i>	±2, ±4, ±8 or ±16 G ± 16 G at 400 Hz LP DC to 3.13 Hz LP up to 400 Hz LP (in power of 2 steps)
<b>Alternative signal:</b>	Tap Event Mark Mode ( <i>replaces</i> G)
<b>Resolution:</b>	X: 5 mg rms, Y: 6 mg rms, Z: 9 mg (rms) (±2 G scale at 400 Hz LP)
<b>Signal range:</b>	<i>Selectable:</i> ±2, ±4, ±8 or ±16 G
<b>Output Voltage range:</b>	±10 V (receiver output)
<b>Operating time:</b>	72-90 hours
<b>Included strap:</b>	33 cm - BN-STRAP33
<b>Input:</b>	Attach BioNomadix transmitter to subject – no additional hardware input required; sensor is internal to transmitter.

Table 5: Common Specs

<b>Operational Range:</b>	10 meters (line-of-sight) typical in standard laboratory setups. See also: <i>Operational Range and Characteristics</i> .
<b>Delay:</b>	Large fixed component (15.6 ms) and small variable component (±0.5 ms rms)
<b>Operating Temp &amp; Humidity:</b>	Temperature: 5-45° C                      Humidity: 95% non-condensing
<b>Size &amp; Weight:</b>	Transmitter: (approx.): 6 cm x 4 cm x 2 cm: 54 grams Receiver: (approx.): 4 cm x 11 cm x 19 cm: 380 grams
<b>Transmitter:</b>	Type: Ultra-low power, 2.4 GHz bi-directional digital RF transmitter Rate: 2,000 Hz (between transmitter and receiver)
<b>Receiver Power:</b>	Use with an MP Research System or with isolated power supply IPS100C for 3rd-party data acquisition system.
<b>Battery &amp; Charger:</b>	BioNomadix transmitters use an L-ion battery: full charge takes approx. 1 hour to provide maximum operating time. A battery charger is included with each module pair. See BN-CHRG for charge time and recharge cycle details.
<b>Compliance:</b>	FCC, CE, IC,  - FCC Part 15 B - FCC ID: receiver: ZWIBNXR1, transmitter ZWIBNXT1 IC: receiver: 9901A-BNXR1, transmitter: 9901A-BNXT1

**BIONOMADIX ELECTRODE LEADS**

All BioNomadix electrode leads use lightweight, insulated tinsel wire 1.25 mm OD with female mini-pinch clips and squeeze lock connectors

**2-LEAD BIONOMADIX ELECTRODES LEADS (also for biopotential Smart Amplifiers)**

- Lead wires: 2 (red and white)
- Electrode clips: 2
- Length: BN-EL15-LEAD2: 15 cm, BN-EL30-LEAD2; 30 cm, BN-EL45-LEAD2; 45 cm
- Interface: Secondary channel lead for the following BioNomadix Transmitters: BN-ECG2, BN-EEG2, BN-EGG2, BN-EMG2, BN-EOG2, (first channel lead should be a BN-ELxx-LEAD3 three lead set to establish ground). *Do not use for EDA or NICO!*

**2-LEAD FOR NICO – BN-EL50-LEAD2**

- Lead wires: 2 (insulated leads black)
- Electrode clips: 2 (alligator clips with teeth)
- Length: 50 cm
- Interface: NICO CH A or CH B

To eliminate redundant ground leads for biopotentials, use 3-lead for primary input and 2-lead for secondary input for each BioNomadix unit.

**3-LEAD BIONOMADIX ELECTRODES LEADS (also for biopotential Smart Amplifiers)**

- Lead wires: 3 (red, white, and black)
- Electrode clips: 3
- Length: BN-EL15-LEAD3; 15 cm, BN-EL30-LEAD3; 30 cm, BN-EL45-LEAD3; 45 cm
- Interface: Primary and secondary channel lead for the following BioNomadix Transmitters: BN-ECG2, BN-EEG2, BN-EGG2, BN-EMG2, BN-EOG2. *Do not use for EDA or NICO!*

**4-LEAD BIONOMADIX ELECTRODE LEADS**

- Leads: 4 (red x 2 and white x 2)
- Electrode clips: 4
- Length: BN-EL50-LEAD4; 50 cm
- Interface: designed for BN-NICO: CH A or CH B (can be used with other BioNomadix biopotential transmitters)
- Connection: See diagram (right) for BN-EL50-LEAD4 leads and EL500 paired spot electrodes.

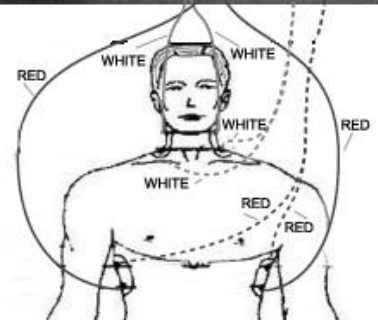

**EDA BIONOMADIX ELECTRODE LEADS (also for Smart Amplifier EDA100D)**

- Leads: 2 (red and black)
- Electrode clips: 2
- Length: BN-EDA-LEAD2; 15 cm, BN-EDA25-LEAD2; 25 cm
- Interface: Only use in CH B EDA on wireless BioNomadix Transmitter BN-PPGED

**BIONOMADIX TO TOUCHPROOF ADAPTERS**

- Leads: 2 (red and white, BN-ADAPT-2) or 3 (red, white and black, BN-ADAPT-3)
- Electrode clips: 2 (BN-ADAPT-2) or 3 (BN-ADAPT-3)
- Length: 10 cm
- Interface: Use these adapters to connect 1.5 mm Touchproof electrodes to a BioNomadix transmitter.

## BIONOMADIX OPERATIONAL RANGE AND TRANSMISSION CHARACTERISTICS

The BioNomadix system is a very low power transmission system designed for physiological measurements in a laboratory setting. In this explanation, a BioNomadix transmitter is referred to as series BN-Tx and a BioNomadix receiver as series BN-Rx.

Primary design objectives for the BioNomadix system:

- 1) BN-Tx and BN-Rx units to emulate operation, as if “attached by cable”
- 2) Transmission effects not to disturb physiological source
- 3) Classification subject to class B digital device pursuant to FCC part 15
- 4) Long BN-Tx operational time, after recharge
- 5) Quick recharge time, under one hour
- 6) Bn-Tx units to be as lightweight, rugged and small as possible
- 7) Minimal user setup required, simply power up and start collecting data

### BioNomadix Operational Range and Characteristics

A primary objective of the BioNomadix System is that it cannot behave in a fashion that would permit any arbitrary time delay between transmitter and receiver. This objective is critical for the BioNomadix System because it insures robust time synchronization between any BN-Tx units and external hardware. Because of the requirement to “behave as though a cable connects BN-Tx and BN-Rx”, the BioNomadix System required a special and optimized protocol to insure the best possible attempts to send data, within a limited (10 sample) time frame. If data could not be sent within this time frame, then data would be replaced with the last data value sent for a short time period (for up to about one second) thereafter until finally, assuming a reconnect was not possible, the transmitted data (not received) will be identified as null (zero) values.

The BioNomadix System operational transmission range is 10 meters line-of-sight, typical, in standard laboratory environments. Operational range can vary depending on factors such as presence of electromagnetic interference, multi-path, or radio frequency signal blocking. In the event of a communications failure, BioNomadix Tx and Rx modules will attempt to re-establish communications until such communications can be re-established.

BioNomadix Tx are purposely kept at very low power so as not to disrupt the sensitive biophysical parameter measured, to enhance battery life, and to satisfy the relevant FCC regulations. If a BN-Tx and BN-Rx pair is used outside of the laboratory (without the benefit of multi-path) and if the BN-Tx is line-of-sight blocked from the BN-Rx, then communication dropouts are increasingly likely. A functional solution is to keep the BN-Tx and BN-Rx in constant line-of-site view.

BioNomadix signal performance is best with “line-of-sight” connection from transmitter unit to receiver unit. Signal dropouts happen when a conductive surface (metal or human body) is placed between the transmitter and receiver unit. If this happens, and there are no other radio frequency reflective surfaces in the room, then the radio waves can’t get from transmitter unit to receiver. This phenomenon is referred to as “body-blocking.” The solution is to place the transmitter and receiver units closer together and to eliminate potential for body-blocking.

### Case studies

- Case 1: Multiple people wearing BioNomadix Tx units are walking around in a room and the BN-Rx units are placed in a nearby room. Periodically, when body blocking occurs, short signal dropouts are noted.  
**Solution 1:** Place the BN-Rx units, with MP160/150, directly above the subjects in the room. This will greatly minimize the potential for body-blocking, from Tx unit to Rx unit, as subjects move around.
- Case 2: Multiple people wearing BioNomadix Tx units are sitting in a room with a central table. The BioNomadix Rx units are placed in a nearby room. Periodically, when body blocking occurs, short signal dropouts are noted.  
**Solution 2:** Mount the receiver (BN-Rx) units, with MP160/150, underneath the center of the table, around which the subjects are sitting. Mount a platform to the underside of the table and rest the receiver with MP160/150 on it. This situation places the receivers just one or two meters away from the transmitters attached to the subjects.

## BioNomadix Transducers

### Pulse BioNomadix Transducer **BN-PULSE-XDCR**

Emitter/Detector Wavelength:	860 nm ± 60 nm
Optical LP Filter Cutoff:	800 nm
	The operational range of the emitter and detector falls within the wavelength range of 800 nm to 920 nm. The filter is placed over the receiver; the filter of 800 nm is an optical lowpass, so wavelengths longer than 800 nm will pass thru.
Nominal Output:	20 mV (peak-peak)
Power:	10 mA drive current
Sterilizable:	Yes (contact BIOPAC for details)
Dimensions (L x W x H):	16 mm x 17 mm x 8 mm
Transducer Weight:	4.5 grams Cable: 45 cm
Interface:	Use in CH A PPG on the BioNomadix BN-PPGED or with Smart Amplifier PPG100D

### Pulse Earclip Transducer **BN-PULSEEAR-XDR**

Emitter/Detector Wavelength:	890 nm (nominal maximum)
Optical Low Pass Filter Cutoff	ambient visible light filter
	The transducer operates with the BioNomadix Pulse Transmitter (BN-PPGED) and consists of a matched infrared emitter and photo-diode, which transmits changes in infrared reflectance resulting from varying blood flow.
Wavelength:	800-1,000 nm (70% spectral response)
Nominal Output:	20 mV (peak-peak)
Power:	10 mA drive current
Sterilizable:	Yes (contact BIOPAC for details)
Dimensions (L x W x H):	16 mm x 17 mm x 8 mm
Transducer Weight:	4.5 grams Cable length: 80 cm
Interface:	Use in CH A PPG on the BioNomadix BN-PPGED or with Smart Amplifier PPG100D

### Respiration Transducer **BN-RESP-XDCR**

Response:	True DC
Circumference Range:	15 cm x 150 cm (increase with a longer strap)
Dimensions:	66 mm (long) x 40 mm (wide) x 15mm (thick)
Weight:	18 grams
Sterilizable:	YES: use standard gas sterilization techniques [i.e., Ethylene Oxide (EtO)]
Variable Resistance Output:	5 - 125 KOhm
Cable:	30 cm
Interface:	BN-RSP2 CH A RSP or CHB RSP, BN-RSPEC CHA RSP, or Smart Amplifier RSP100D

**Clench Force Transducer**

Pressure Range:	0 to 1.0546 Kg-f/cm <sup>2</sup> (0 to 15 psi)
Error Band:	± 2% full scale
Accuracy:	±25% full scale – best fit straight line
Output:	25 mV/0.01 Kg-f/cm <sup>2</sup> (0.176 V/psi)
Bulb Diameter:	5.8 cm
Bulb Length:	11.1 cm
Weight:	108 grams
Cable Length:	45 cm
Interface:	Use with the BN-DYNEMG Dynamometer and EMG module

**BN-CLENCH-XDCR****Heel-Toe Strike Transducer**

Nominal Output Range:	-1 to +1 Volt
Nominal Contact Force:	200 g to indicate heel-toe strike
Attachment:	TAPE 1, TAPE 2, vinyl electrical or duct tape
FSR Dimensions:	18.3 mm (dia) x 0.36 mm (thick) and 30 cm pigtail lead
FSR Active Area:	12.7 mm diameter
Interface:	BN-STRIKE transmitter (STRK A, STRK B)

**BN-STRIKE-XDCR****Skin Temperature Transducer**

Nominal Resistance:	2252 ohm at 25° C
Maximum operating temperature:	60° C
Accuracy and Interchangeability:	0.2° C
Response Time:	1.1 sec (attached to skin)
Compatibility:	YSI series 400 temperature probes
Sterilizable:	NO (Not designed for immersion)
Cable:	30 cm
Dimensions:	9.8 mm (diameter) x 3.3 mm (high)
Interface:	BN-SKT2 only: CH A SKT and/or CH B SKT, or Smart Amplifier SKT100D

**BN-TEMP-A-XDCR****Skin Temperature Transducer**

Nominal resistance:	2252 ohm @ 25° C
Maximum operating temperature:	60° C (when used with BN-SKT2)
Accuracy and Interchangeability:	0.2° C
Response Time:	0.6 sec (in air)
Compatibility:	YSI series 400 temperature probes
Sterilizable:	NO (Not designed for immersion)
Cable:	30 cm
Dimensions:	1.7 mm (diameter) x 5 mm (long)
Interface:	BN-SKT2 only: CH A SKT and/or CH B SKT, or Smart Amplifier SKT100D

**BN-TEMP-B-XDCR (Fast Response)**

Goniometer & Torsiometer Transducers BN-GON-XDCR, BN-TOR-XDCR, BN-GON-F-XDCR

Use with BN-GONIO Goniometry Module.

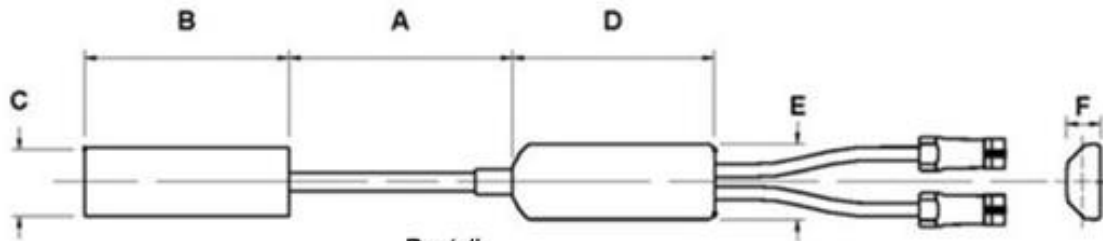

	Part #				
	BN-GON-110-XDCR	BN-GON-150-XDCR	BN-TOR-110-XDCR	BN-TOR-150-XDCR	BN-GON-F-XDCR
<b>BioNomadix via BN-GONIO</b>					
<b>Number of channels</b>	2	2	1	1	1
<b>Measuring range</b>	±150	±150	±150	±150	±150
<b>Dimensions mm</b>					
<b>A. Maximum</b>	110	150	110	170	35
<b>A. Minimum</b>	70	100	70	115	30
<b>B.</b>	60	70	60	70	18
<b>C.</b>	18	18	18	18	8
<b>D.</b>	54	54	54	54	15
<b>E.</b>	20	20	20	20	8
<b>F.</b>	9	9	9	9	5
<b>Bend radius (mm) – min.</b>	18	18	18	18	3
<b>Weight (g)</b>	23	25	22	23	8
<b>Crosstalk<sup>1</sup></b>	±5%	±5%	N/A	N/A	N/A
<b>Nominal Output</b>	5 µV/degree normalized to 1 V excitation				
<b>Temperature Zero Drift</b>	0.15 degrees angle / °C				
<b>Cable length</b>	6 m				
<b>Endblock height</b>	Cable end 9.4 mm, distal end 8.2 mm				
<b>Transducer type</b>	Strain gauge				
<b>Life<sup>2</sup></b>	600,000 cycles minimum				
<b>Accuracy</b>	±2° measured over 90° from neutral position				
<b>Repeatability</b>	Better than ±1°				
<b>Analog resolution</b>	Infinite				
<b>Operating temp range</b>	+0° to +40° C				
<b>Storage temp range</b>	-20° C to +50° C				
<b>Operating/Storage humidity range</b>	30% to 75%				
<b>Atmospheric pressure range</b>					
<b>Operation</b>	700hPa to 1060hPa				
<b>Storage</b>	500hPa to 1060hPa				

<sup>1</sup> Specification of crosstalk for all Biometrics twin axis SG series goniometers is measured over ± 60°. i.e. if a joint is moved through 60° from the neutral position in one plane without movement in the orthogonal plane, then the sensor output in the orthogonal plane may change by a maximum ±3°.

<sup>2</sup> Life test results have been collected by cycling the sensors through movements that would happen during everyday use. For example, placing a sensor on an adult elbow and moving from the neutral position to maximum flexion and back to the neutral position, the unit will function for a minimum of 600,000 cycles.

**BIONOMADIX ACCESSORIES SPECS**

**BioNomadix Shirt**

Attachment Features: 22 pockets: 2 neck front, 2 neck back, 4 chest center, 4 back center, 2 hip front, 2 hip back, 3 left arm, 3 right arm  
 4 zippers: right front from arm to hip, left back from shoulder to hip, right and left under arm from neck front to neck back  
 4 strap bands: 4 rows of strap bands (2 loops front, 2 loops back) for RSP transducer strap

Materials: Black 6 oz. eyelet mesh 88% Polyester / 12% Spandex; metal zippers

Sizes: BN-SHIRT-XS extra small                      BN-SHIRT-L large  
 BN-SHIRT-S small                                      BN-SHIRT-XL extra large  
 BN-SHIRT-M medium

Care instructions: Machine Wash, Warm / Line Dry

**BioNomadix Strap**

Dimensions: Length 20 cm, 33 cm, 76 cm, 137 cm (all widths 2.5 cm)  
 Material: stretch Velcro® - hook/loop type  
 Use with: BioNomadix Transmitters

Length: BN-STRAP-20; 20 cm                                      BN-STRAP-33; 33 cm  
 BN-STRAP-76; 76 cm    BN-STRAP-137; 137 cm

**BioNomadix 10/20 EEG Cap System**

Attachment: Ribbon cable (25 cm) from cap to 19 Touchproof (1.5 mm) sockets  
 Material: Lycra  
 Use with: BN-EEG2  
 Lead adapters: BN-ADAPT-TP2 or BN-ADAPT-TP3 depending on sites to be recorded  
 Sizes: BN-CAP-SMALL (50-54 cm,) BN-CAP-MEDIUM (54-58 cm,) BN-CAP-LARGE (58-62 cm)

Components:  
 1 x medium cap with 19-pin ribbon cable  
 1 x mating cable with 1.5 mm Touchproof connectors  
 2 x earclip reference electrodes  
 1 x blunt-tipped syringe  
 1 x EEG recording gel  
 1 x chest harness (holds cap in place)  
 1 x liquid soap (to wash cap after use)

WHITE TIP	WIRE COLOR	RED TIP
Fp1	Brown	Fp2
F3	Red	F4
C3	Orange	C4
P3	Yellow	P4
01	Green	02
F7	Blue	F8
T3	Violet	T4
T5	Gray	T6
Gnd	White	Cz
Fz	Black	Pz



**BioNomadix Battery Charger: BN-BAT-CHRG**

*To charge, the BioNomadix Transmitter must be in the OFF position and have no electrode leads or transducers attached.*

Connector:	DC polarized squeeze-clip plug to mate with all BioNomadix Transmitters
Number of cells:	1 L-ion
Charger current	1000 mA (660 mA for IB-16800)
Current tolerance:	+10%
Voltage limit:	Preset
Voltage limit tolerance:	+0.2%
Operating temperature:	0° C to 40° C
Input voltage:	90 VAC to 240 VAC
Frequency	50 Hz to 60 Hz
Wall plug:	ships with US blades; adapters available for Euro, China or Australia
Output cable length:	1.7 meter (~6 feet)
Connector	DC polarized squeeze-clip plug to mate with all BioNomadix Transmitters
Weight:	142 grams (5 oz.)
Dimensions:	75 mm x 51 mm x 40 mm
Lithium Ion Chemistry	
Termination algorithm:	CCCV
Termination indicated	Current falls to limit value/5
Top-off charge:	1 hour or current falls to limit value/10
Restart threshold:	7/8 of termination voltage or every 2 hours
Maintenance charge:	N/A
Charge voltage limit:	Preset to 4.20 V (one L-ion cell)
Override timer:	None

**IMPORTANT:** *If the transmitter is to be stored for prolonged periods, it is strongly recommended that the battery be fully charged and the transmitter turned off prior to storage. Failure to do so may result in permanent damage to the battery. To avoid shortening battery life, it is also recommended that transmitter be disconnected from the charger prior to storing for long periods. For extremely long-term disuse, transmitter should be charged once a month, then disconnected between charge cycles.*

## BIONOMADIX COMPLIANCE STATEMENT

*This device complies with part 15 of the FCC Rules. Operation is subject to the following two conditions: (1) This device may not cause harmful interference, and (2) this device must accept any interference received, including interference that may cause undesired operation.*

## INDUSTRY CANADA INFORMATION

*Under Industry Canada regulations, this radio transmitter may only operate using an antenna of a type and maximum (or lesser) gain approved for the transmitter by Industry Canada. To reduce potential radio interference to other users, the antenna type and its gain should be so chosen that the equivalent isotropically radiated power (e.i.r.p.) is not more than that necessary for successful communication.*

*This radio transmitter (IC: 9901A-BNXR1) has been approved by Industry Canada to operate with the antenna types listed below with the maximum permissible gain and required antenna impedance for each antenna type indicated. Antenna types not included in this list, having a gain greater than the maximum gain indicated for that type, are strictly prohibited for use with this device.*

WLAN antenna, maximum gain 1.5 dBi, 50 ohm

*This device complies with Industry Canada licence-exempt RSS standard(s). Operation is subject to the following two conditions: (1) this device may not cause interference, and (2) this device must accept any interference, including interference that may cause undesired operation of the device.*

*Conformément à la réglementation d'Industrie Canada, le présent émetteur radio peut fonctionner avec une antenne d'un type et d'un gain maximal (ou inférieur) approuvé pour l'émetteur par Industrie Canada. Dans le but de réduire les risques de brouillage radioélectrique à l'intention des autres utilisateurs, il faut choisir le type d'antenne et son gain de sorte que la puissance isotrope rayonnée équivalente (p.i.r.e.) ne dépasse pas l'intensité nécessaire à l'établissement d'une communication satisfaisante.*

*Le présent émetteur radio (IC: 9901A-BNXR1) de modèle s'il fait partie du matériel de catégorie I) a été approuvé par Industrie Canada pour fonctionner avec les types d'antenne énumérés ci-dessous et ayant un gain admissible maximal et l'impédance requise pour chaque type d'antenne. Les types d'antenne non inclus dans cette liste, ou dont le gain est supérieur au gain maximal indiqué, sont strictement interdits pour l'exploitation de l'émetteur. réseau local sans fil antenne, le gain max 1.5 dBi, 50 ohm*

*Le présent appareil est conforme aux CNR d'Industrie Canada applicables aux appareils radio exempts de licence. L'exploitation est autorisée aux deux conditions suivantes : (1) l'appareil ne doit pas produire de brouillage, et (2) l'utilisateur de l'appareil doit accepter tout brouillage radioélectrique subi, même si le brouillage est susceptible d'en compromettre le fonctionnement.*

## CLASS A ITE

この装置は、クラスA情報技術装置です。この装置を家庭環境で使用すると電波妨害を引き起こすことがあります。この場合には使用者が適切な対策を講ずるよう要求されることがあります。VCCI-A

## BIONOMADIX—OPTIONAL CALIBRATION

### Isolated Power Supply

To use BioNomadix with the Isolated Power Supply (IPS100C), use CBL102 cable to connect the IPS100C to the Receiver output channel. This is accessible via the front panel of the IPS100C.

### Signal Validation

BioNomadix units are factory calibrated, but if user-calibration is desired for measurement verification, the following steps may be used. Please see the appropriate section for BioNomadix calibration guidelines.

- BN-ECG, BN-EEG, BN-EGG, BN-EMG, BN-EOG
- BN-EDA
- BN-NICO
- BN-PPG and BN-RSP
- BN-SKT
- BN-GON and BN-TOR
- BN-STRIKE
- BN-DYNEMG
- BN-ACCL

## BN-ECG, BN-EEG, BN-EGG, BN-EMG, BN-EOG BIOPOTENTIAL CALIBRATION

Three alligator clips will be required to calibrate a Biopotential Transmitter/Receiver set.

- 1) Attach alligator clip to LEAD side of electrode pinch clip (see figure on right).
- 2) Connect black and white pinch clips together (this combination is attached to signal generator ground).
- 3) Connect red pinch clip to signal generator output for the Transmitter/Receiver set.



- ECG, EGG, EMG, EOG

The signal generator should be set to 1 mV peak to peak sine wave in the appropriate signal frequency range for the Transmitter/Receiver set. The total gain of the Transmitter/Receiver set is 2,000. The measured output voltage from the Receiver should be 1 mV p-p \* 2000 or 2 V p-p. The maximum input signal is 10 mV p-p.

- EEG

The signal generator should be set to 1 mV peak to peak in the appropriate signal frequency range for the Transmitter/Receiver set. The total gain of the Transmitter/Receiver set is 10,000. The measured output voltage from the Receiver should be 1 mV p-p \* 10,000 or 10 V p-p. The maximum input signal is 2 mV p-p.

**BN-EDA ELECTRODERMAL CALIBRATION**

Transmitter/Receiver set can be calibrated by applying a known resistance (conductance) to the EDA electrode pinch connectors via alligator clips. Suggested values of conductance would be 0  $\mu$ Siemens (infinite ohms – no connection) and 10  $\mu$ Siemens (100 K ohms). The EDA Transmitter/Receiver set outputs +10 V for a 50  $\mu$ S measured conductance. The EDA Transmitter/Receiver set will output approximately +2 V for a 10  $\mu$ S measured conductance.

**BN-NICO CALIBRATION**

**Mapping for Z:**                      0.8 V to 10 ohms                      9 V to 100 ohms

The calibration values for Z are approximate. For a more exact calibration for Z, introduce a 10 ohm resistor between the paired leads (Iout, Vin+) and (Vin-, Iin) to simulate a 10 ohm impedance magnitude. Use a 100 ohm resistor to simulate a 100 ohm impedance magnitude. See figure at right for details:

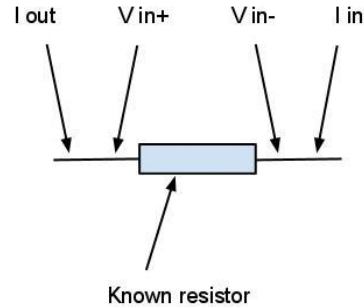

For the most accurate calibrations, use known impedances (resistances) that bracket the expected high and low values being recorded. For conventional noninvasive cardiac output measurements, optimal low impedance is 15 ohms and optimal high impedance is 40 ohms.

**Mapping for dZ/dt:**                      0 V to 0 ohms/sec                      10 V to 10 ohms/sec

The calibration values for dZ/dt can be accomplished by introducing a known and varying resistance that can be precisely set to a specific rate of change. For calibration related to cardiac output measurements, a varying resistance of  $\pm 1$  ohms/seconds to  $\pm 5$  ohms/second is ideal. A photonicly-isolated voltage controlled resistance can be used for this calibration. A cadmium sulfide cell in parallel with a resistance of 25 ohms can be employed in conjunction with a signal generator driven LED to provide a varying light intensity to modulate the resistance of the cadmium sulfide cell.

**BN-PPG AND BN-RSP PULSE AND RESPIRATION CALIBRATION**

**User-calibration not recommended**, as the measurements performed are essentially dimensionless. However, it's possible to calibrate the PPG Transmitter/Receiver set by introducing a variable gray-scale density pattern to the PPG probe in a dark environment. The RSP Transmitter/Receiver set can be calibrated by applying differing amounts of force to the RSP transducer/belt combination to stretch the belt over different distances.

**BN-SKT SKIN TEMPERATURE CALIBRATION**

Insert probe into temperature well set to the appropriate temperature. As an alternative, replace the thermistor with known temperature(s) that reflects the specific temperature(s) simulated. The temperature probe specifications are equivalent to YSI@ 400 series probes. The temperature range for the SKT Transmitter/Receiver set is 13 to 51 degrees C. Using the specified temperature probe: 13 degrees provides a -10 V output and 51 degrees provides a +10 V output.

## BN-GON, BN-TOR GONIOMETER CALIBRATION

This is general calibration information for all BIOPAC Goniometers and Torsiometers:

When using all goniometers and torsiometers, the minimum value of bend radius must be observed at all times, particularly when attaching and removing the sensors from the subject. Failure to do this will result in reduced unit life or failure.

The sensors have been designed to be as light as possible and the operating force to be a minimum. This permits free movement of the joint without influence by the sensors. The sensors measure the angle subtended between the endblocks. Use the software calibration features (under Setup Channels) to calibrate any of the BIOPAC series goniometers.

Each goniometer requires a DA100C amplifier, BN-GONIO, or MP3X/45 analog input per rotational axis. Accordingly, the twin axis goniometers will need two DA100C amplifiers, one BN-GONIO or two MP3X/45 analog channels to simultaneously measure both rotational axes.

Excitation voltages are factory preset for the various data acquisition platforms, however excitation voltages are user-adjustable on the DA100C. Recommended excitation is +5VDC.

1. Place goniometer with care to verify that limb/joint/torso attachment will not result in over stretch at the limits of limb/joint/torso movement
2. Put body in the first position, which brackets one end of range of movement. Press CAL 1.
3. Put body in the second position, which brackets The other end of range of movement. Press CAL 2.

## BN-STRIKE HEEL-TOE STRIKE CALIBRATION

BN-Strike requires no calibration.

## BN-DYNEMG CALIBRATION

The BN-DYNEMG needs consideration for calibration on pressure bulb.

The pressure bulb transducer measures applied hand grip strength, via pressure changes manifesting in the bulb, during squeezing. The units of pressure are force per unit area. The pressure bulb transducer configuration determines the factory preset scaling, typically in units of kg/m<sup>2</sup> or kg/cm<sup>2</sup>. If another or different calibration required, the following method can be used.

To calibrate:

1. Place bulb on flat, stable, drawing surface
2. Press CAL 1 - enter 0 kg/unit area
3. Place known weight on bulb (X- kg)
4. Use pencil to outline flattened portion of bulb on table, use ruler to measure the flattened area outline from side to side, and record this value as area "A"
5. Press CAL 2 - enter X/A kg/unit area

### BN-ACCL ACCELEROMETER CALIBRATION

Orient Transmitter unit in the X, Y, and Z directions with respect to Earth’s gravity. This action will introduce 1 G in positive axis direction and -1 G in the negative axis direction. The accelerometer Transmitter/Receiver set has user-selectable ranges:  $\pm 2$ ,  $\pm 4$ ,  $\pm 8$  or  $\pm 16$  G. The maximum value of each range selection provides a +10 V output and the minimum value of each range selection provides a -10 V output. When using the  $\pm 2$  G range, a + 1 G input will provide a +5 V output and a -1 G input will provide a -5 V output, when properly scaled.

The BN-ACCL has a factory default of  $\pm 16$  G. Use the DIP switches on the side of the BN-ACCL Receiver Module to set the Transmitter to the desired range. If the range needs to be set to something other than  $\pm 16$  G, perform the following steps prior to calibration using Earth’s gravity, as described in the previous paragraph.

1. In *AcqKnowledge*, select “**Set Up Data Acquisition > Channels.**”
2. Select “**View by Modules...**” and add new module “**ACCL3-R,**” assuming not yet added.
3. Select the desired X, Y and Z channels and click **OK** (see right).
4. Then select “**View by Channels...**”. Click the “**Setup**” button.
5. Click “**Yes**” to the channel scaling modification prompt.

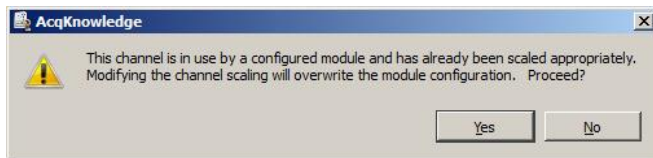

6. Set desired Scaling as shown in the following table and click **OK**:

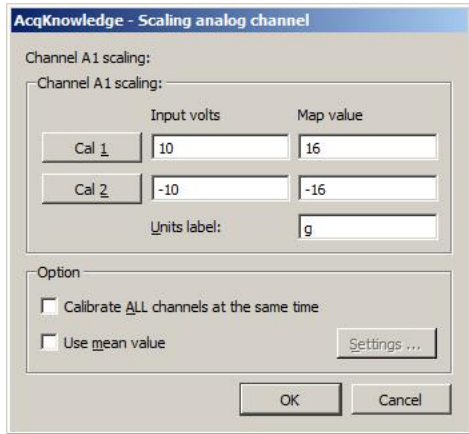
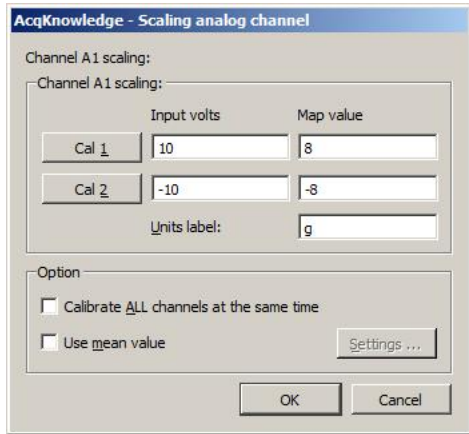
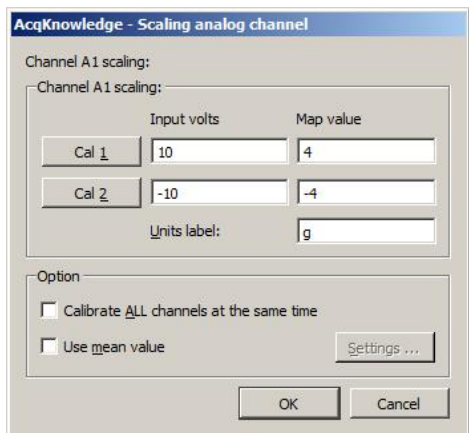
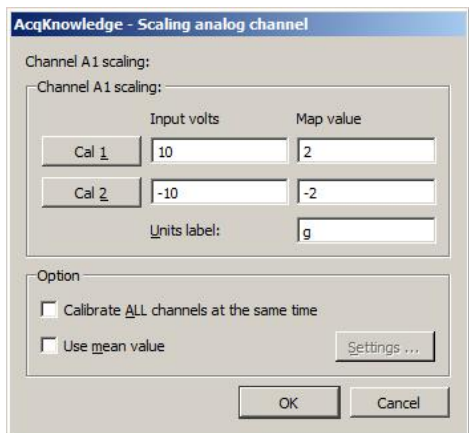
±16 G Range	±8 G Range
	
±4 G Range	±2 G Range
	



**FILTER OPTION SWITCH GUIDE**

Switches are on the side of the BioNomadix receiver when pulled apart from other modules. Adjust switch position with a small tipped screwdriver.



Switch positions: “UP” = ON, DOWN” = OFF

**NOTE:** If the switch settings are modified, preset MP160/150 module setup cannot be used and channels must be configured manually.

**Mains Notch Filter**

- All modules except ACCL3 and NICO

Notch Filter	SW1	SW2
60 Hz	UP	DOWN
50 Hz	UP	UP
OFF	DOWN*	DOWN or UP

\*indicates Factory Preset

**BioNomadix Receiver Switches**

- SW3 is ignored if Alternative Signal is enabled (UP)

ECG2-R BioNomadix Receiver	
Filter Option	Switch Number
High Pass	SW3
0.05 Hz HP	DOWN
1 Hz HP	UP*
Low Pass	SW4
35 Hz LP	UP*
150 Hz LP	DOWN

\* indicates Factory Preset

EMG2-R BioNomadix Receiver	
Filter Option	Switch Number
High Pass	SW3
5 Hz HP	DOWN
10 Hz HP	UP*
Low Pass	SW4
250 Hz LP	UP
500 Hz LP	DOWN*

EEG2-R BioNomadix Receiver	
Filter Option	Switch Number
High Pass	SW3
0.1 Hz HP	DOWN
0.5 Hz HP	UP*
Low Pass	SW4
35 Hz LP	UP*
100 Hz LP	DOWN

EOG2-R BioNomadix Receiver	
Filter Option	Switch Number
High Pass	SW3
0.005 HP	DOWN*
1 Hz HP	UP
Low Pass	SW4
35 Hz LP	UP*
100 Hz LP	DOWN

EGG2-R BioNomadix Receiver	
Filter Option	Switch Number
Low Pass	SW3
1 Hz HP	UP*
Disabled	DOWN

SKT2-R BioNomadix Receiver		
Filter Option	CH A	CH B
Low Pass	SW3	SW5
10 Hz LP	DOWN	DOWN
1 Hz LP	UP**	UP*

RSP2-R BioNomadix Receiver			* indicates Factory Preset	PPGED-R BioNomadix Receiver		
Filter Option	CH A	CH B		Filter Option	PPG CH A	EDA CH B
Low Pass	<b>SW3</b>	<b>SW5</b>		Low Pass	<b>SW3</b>	<b>SW5</b>
10 Hz LP	DOWN	DOWN		3 Hz LP	UP*	UP*
1 Hz LP	UP*	UP*		10 Hz LP	DOWN	DOWN
High Pass	<b>SW4</b>	<b>SW6</b>		High Pass	<b>SW4</b>	<b>SW6</b>
0.5 Hz HP	UP	UP		0.5 Hz HP	UP*	UP
DC	DOWN*	DOWN*	DC	DOWN	DOWN*	

RSPEC-R BioNomadix Receiver				
Filter Option	RESP CH A		ECG CH B	
Low Pass	<b>SW6</b>		<b>SW4</b>	
	1 Hz LP	UP*	35 Hz LP	UP*
	10 Hz LP	DOWN	150 Hz LP	DOWN
High Pass	<b>SW7</b>		<b>SW3</b>	
	0.5 Hz HP	UP	1 Hz HP	UP*
	DC	DOWN*	0.05 Hz HP	DOWN

NICO-R BioNomadix Receiver		
Filter Option	Switch Number	
Low Pass	<b>SW1 (Z CH)</b>	<b>SW2 (dZ CH)</b>
5 Hz LP	UP	UP
Low Pass	<b>SW3 (Z CH)</b>	<b>SW4 (dZ CH)</b>
3 Hz LP	UP	UP
Low Pass	<b>SW5 (ZCH)</b>	<b>SW6 (dZ CH)</b>
1 Hz LP	UP	UP
DC to 50* Hz	DOWN for all switches*	

\*Bandlimited to 10 Hz in BN-NICO units shipped before 11/2016

DYNEMG BioNomadix Receiver				
Filter Option	DYN CH A		EMG CH B	
Low Pass	<b>SW6</b>		<b>SW4</b>	
	3 Hz LP	UP	250 Hz LP	UP
	100 Hz LP	DOWN*	500 Hz LP	DOWN*
	<b>SW7</b>		<b>SW5</b>	
	10 Hz LP	UP*	Envelope detection mode EMG CH B	UP
	100 Hz LP	DOWN	EMG signal output	DOWN*
High Pass	HP N/A for DYN		<b>SW3</b>	
	--	--	10 Hz HP	UP*
	--	--	1.0 Hz HP	DOWN



G-Mode	ACCL3-R BioNomadix Receiver				
	Filter Option		Switch Number		
	Nyquist	Rate	SW1	SW2	SW3
	3.13 Hz	6.25 Hz	UP	UP	UP
	6.25 Hz	12.5 Hz	DOWN	UP	UP
	12.5 Hz	25 Hz	UP	DOWN	UP
	25 Hz	50 Hz	DOWN	DOWN	UP
	50 Hz	100 Hz	UP	UP	DOWN
	100 Hz	200 Hz	DOWN	UP	DOWN
	200 Hz	400 Hz	UP	DOWN	DOWN
400 Hz	800 Hz	DOWN*	DOWN*	DOWN*	
Range		SW4		SW5	
2 G		UP		UP	
4 G		DOWN		UP	
8 G		UP		DOWN	
16 G		DOWN*		DOWN*	



**ALTERNATIVE SIGNAL SWITCH GUIDE**

**Warning:** Alternative signal *replaces* the raw signal. To display raw and processed signal alternative(s), use AcqKnowledge calculation channels.

ECG2-R and RSPEC-R BioNomadix Receivers		EOG2-R BioNomadix Receiver	
Signal Output	SW5	Signal Output	SW5
ECG – Factory Preset	DOWN	EOG – Factory Preset	DOWN
Heart Rate – Alternative Signal	UP	Derivative – Alternative Signal	UP

EEG2-R BioNomadix Receiver				
Signal Output	SW5	SW6	SW7	SW8
EEG – Factory Preset	DOWN	DOWN	DOWN	DOWN
Delta – Alternative Signal	UP	DOWN	DOWN	DOWN
Theta – Alternative Signal	--	UP	DOWN	DOWN
Alpha – Alternative Signal	--	--	UP	DOWN
Beta – Alternative Signal	--	--	--	UP

EMG2-R BioNomadix Receiver	
Signal Output	SW5
EMG – Factory Preset	DOWN
Integrated RMS Alternative Signal (Envelope Detection Mode)	UP

ACCL3-R BioNomadix Receiver		ACCL3-R switch settings for Alternative Signal TAP				
G – Factory Preset	DOWN	Tap-Mode	Filter Option	Switch Number		
Tap (Event Mark) – Alternative Signal	UP		Rate (G-Mode) or Duration (Tap Mode)	SW1	SW2	SW3
Signal Output	SW6		5000 $\mu$ S	UP	UP	UP
G-Mode	DOWN		4375 $\mu$ S	DOWN	UP	UP
Tap Mode	UP		3750 $\mu$ S	UP	DOWN	UP
			3125 $\mu$ S	DOWN	DOWN	UP
			2500 $\mu$ S	UP	UP	DOWN
			1875 $\mu$ S	DOWN	UP	DOWN
			1875 $\mu$ S	UP	DOWN	DOWN
			625 $\mu$ S	DOWN	DOWN	DOWN
			Range (G-Mode) or Threshold (Tap Mode)	SW4		SW5
			2 G	UP		UP
			4 G	DOWN		UP
			6 G	UP		DOWN
		8 G	DOWN		DOWN	

GONIO-R BioNomadix Receiver				
Filter Option	CH A		CH B	
Low Pass	SW3		SW5	
	3 Hz LP	UP	3 Hz LP	UP
	100 Hz LP	DOWN*	100 Hz LP	DOWN*
	SW4		SW6	
	10 Hz LP	UP*	10 Hz LP	UP*
	100 Hz LP	DOWN	100 Hz LP	DOWN

STRIKE-R BioNomadix Receiver				
Filter Option	CH A		CH B	
Low Pass	SW3		SW5	
	3 Hz LP	UP	3 Hz LP	UP
	100 Hz LP	DOWN*	100 Hz LP	DOWN*
	SW4		SW6	
	10 Hz LP	UP*	10 Hz LP	UP*
	100 Hz LP	DOWN	100 Hz LP	DOWN